



Product Familiarization & Installation Guide

Abseco® AFi Series Smart Switch
AFI- 4MIS1P

*Revision No.: Initial Issue
Dated: Aug 01, 2021
Printed in India*

Abseco International Pvt. Ltd.



Copyright Information

Copyright ©2021 by Abseco International Pvt. Ltd.

All rights reserved. No part of this publication or design may be reproduced, distributed, or transmitted in any form or by any means, including photocopying, recording, or other electronic or mechanical methods, without the prior permission of the publisher.

Notice

The only warranties for Abseco products and services are set forth in the express warranty statements accompanying such products and services. Nothing herein should be construed as constituting an additional warranty. Abseco shall not be liable for technical or editorial errors or omissions contained herein. The Abseco International Pvt. Ltd shall not be liable for incidental or consequential damages in connection with, or arising out of the furnishing, performance, or use of this document and the program material which it describes.

Trademarks

- ABSECO, the Abseco logo, and Afi Series are property of Abseco International Pvt. Ltd.
- The Works with Google Assistant logo is a trademark of the Google Inc.
- Amazon Alexa, Works with Amazon Alexa are registered trademarks of Amazon.com, Inc.
- The Bluetooth word mark and logos are owned by the Bluetooth SIG, Inc. and any use of such marks by Abseco is with approval.
- Other brands and their products are trademarks or registered trademarks of their respective holders.
- The copyrights to certain photos within this document are retained by the original owners.

Warranty

All electronic devices are warranted against manufacturing defects for two years from the date of purchase. In the event of defects, Abseco will repair or, at its discretion, replace the warranted product if delivered to an Abseco authorized dealer along with a duly stamped guarantee card and sales receipt that shows the date of purchase along with the serial no. of the product. This warranty excludes defects due to abnormal load, abuse or failure to use the product in accordance with the instructions. Abseco shall not be liable for any other damages, whether incidental, consequential or otherwise.

Introduction

Abseco® AFI Series Smart Switch module is an innovative, futuristic and affordable smart automation device which give users total control of their lights, appliances and electrical outlets through various control methods such as smartphones, voice assistants, network profiles, and cloud services such as IFTTT.

Our smart-touch solution provides a comprehensive automated home or business electrical control ecosystem, offering users unparalleled levels of control and visibility over their home or business lighting, heating, and cooling systems, all delivered in one affordable, accessible, and easy-to-use package.

Safety Information

Always follow all basic electrical/electronic safety precautions when using this smart switch (product) to prevent risk of injury from fire or electric shock, or product damage.

- Read and understand all guidelines provided in this document regarding safety, warranty, installation, and use before installation/use of the product.
- All instructions and safety precautions detailed in this guide must be strictly followed. Observe all warnings and instructions marked on the product.
- If the instructions and safety precautions detailed in this manual are not correctly followed, Abseco International Pvt. Ltd. cannot be held responsible for any personnel injury and/or equipment/product damage.
- To prevent electric shock, disconnect both the poles of the main supply before installing the product.
- Do not install this product where it can come in contact with water. Never do installation of the product with wet hands. Dry your hands to avoid electrical shock/injury.
- Product must be installed securely on a wall/surface without uneven gaps.
- This product is a single pole switch and disconnects only one pole when it is in OFF condition.
- Installation of the product must be performed by a qualified electrical technician.
- Product damage caused by incorrect installation or use is not covered under warranty and the related warranty claims will be rejected.
- There are no user serviceable parts inside the product. Product repair/servicing must only be carried out by a qualified service personnel authorized by the company.

Main Features

- Works with Amazon Alexa and Google Home, commanded by your voice
- Control your home with your smartphone or tablet from anywhere any time with Abseco App
- Refined look and feel
- Made of fire resistant, safe and durable materials
- Waterproof tempered glass touch panel with advance capacitive touch technology
- Multiple colour choices to choose from to match with any room decor
- Standalone smart switch module – no need for a separate control hub
- Inbuilt overload and surge protection
- Functional module design to easily replace your traditional mechanical switch
- Separate indicators for on/off status and touch switch illumination for ease of detection during night
- Simple retrofit installation; does not require special wiring
- Employs microprocessor for saving presets and functional status in case of power failure
- Out of the box compatibility for 2-Way connection
- Inbuilt sub-metering capability

Technical Specifications

Parameter	Specification
Switch Classification	Wi-Fi Smart Wall Power Socket & Switch
Model No.	AFI-4MIS1P
Power Supply Mode	Live Wire; Requires a Neutral Line
Rated Current	16 A
Rated Voltage and Frequency	100-250 VAC, 50-60 Hz
Wi-Fi Frequency	2.4 GHz
Wireless Standard	IEEE802.11 b/g/n
Bluetooth Version	4.2

Parts Identification

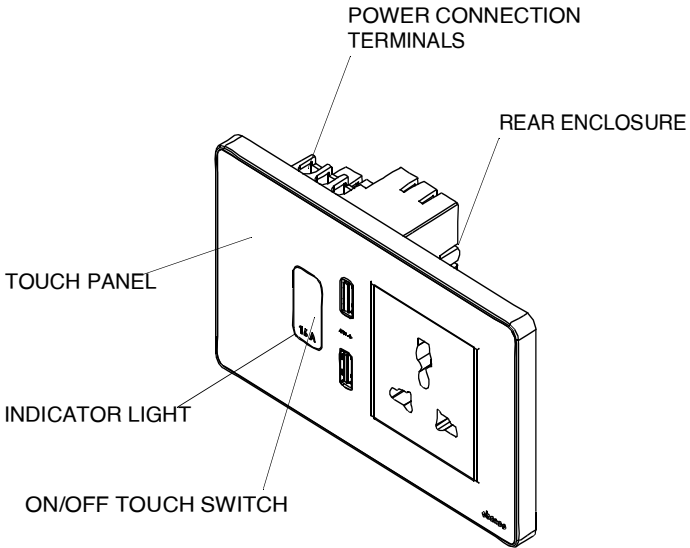

Power Connection Terminals

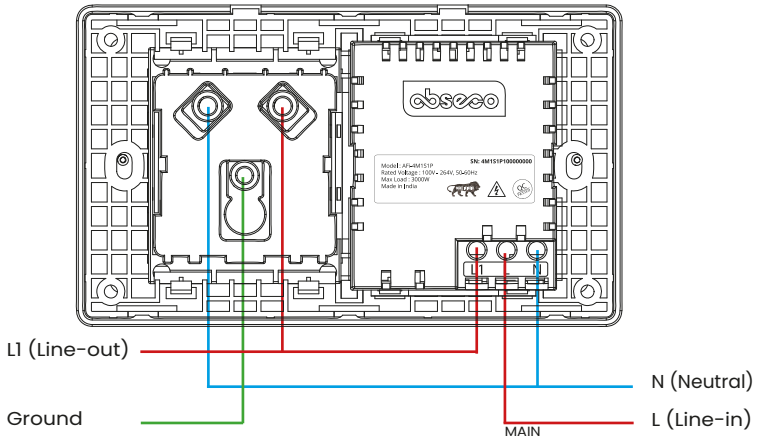

Installation Instructions

1. Connect the electrical wires to the terminals of the switch module as shown in the wiring diagram for either 1-Way or 2-Way installation.

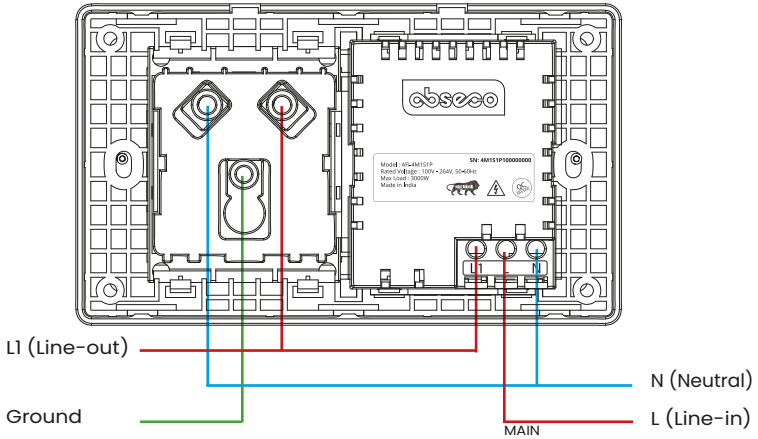

2. Insert the switch module into the switch mount box and secure with 2 screws.

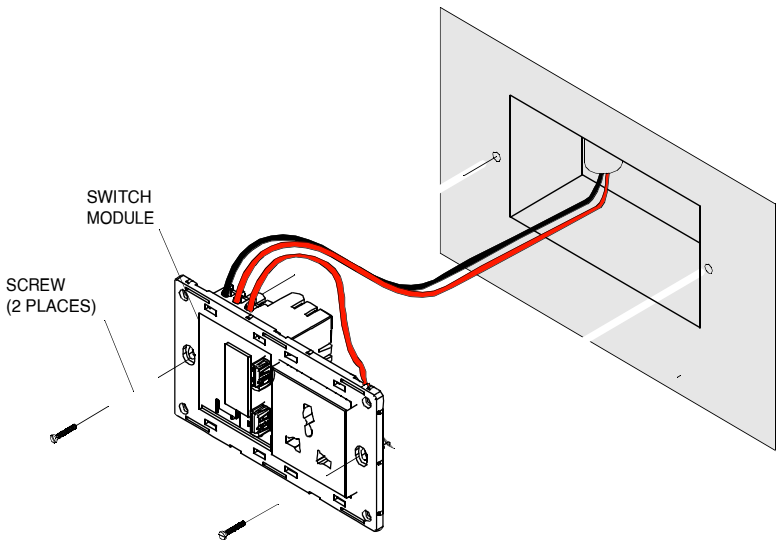

3. Align and position the front touch panel (face plate) onto the switch module.

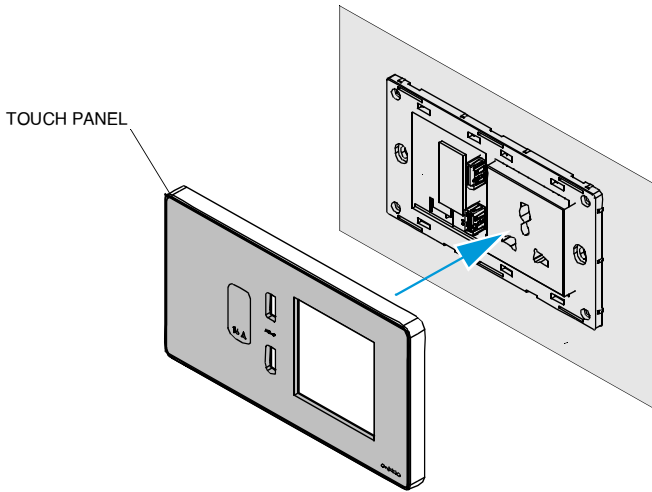
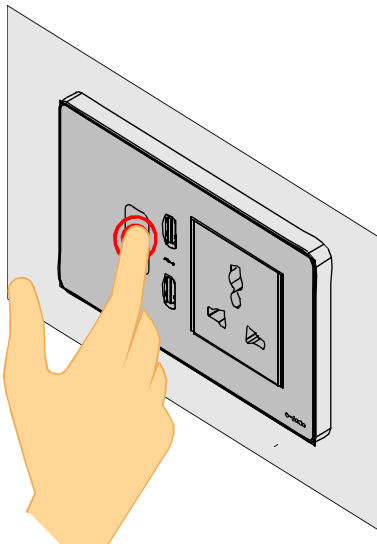

Figure 2B: Wiring Diagram - 2-Way Installation

4. Carefully press the touch panel by applying even force on all sides until it is seated securely on the switch module.
Make sure that the touch panel is seated correctly without any uneven gaps.



5. After installation, switch on the main electrical power supply and verify that the touch switch is working correctly.

Setting Up the Smart Switch – Installing Abseco Smart App and User Registration

1. Install the Abseco App on your smartphone or tablet.

Open Google Play Store or Apple Store, then search for Abseco App and install it.



2. Open the Abseco App and select “Sign Up” option.

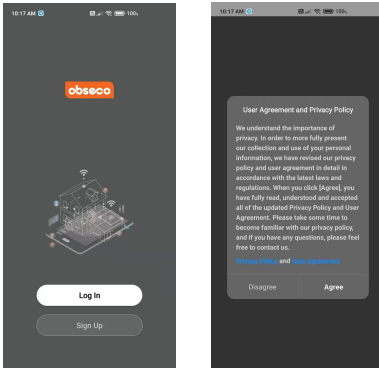

You will be presented with a User Agreement and Privacy Policy screen. Read the user agreement and privacy policy and select “Agree” to continue to the user registration screen.

3. To register yourself on the App, select your country from the selection field and enter a valid email address or mobile number and select “Get Verification Code”.

NOTE: Country/region once set during registration cannot be changed.

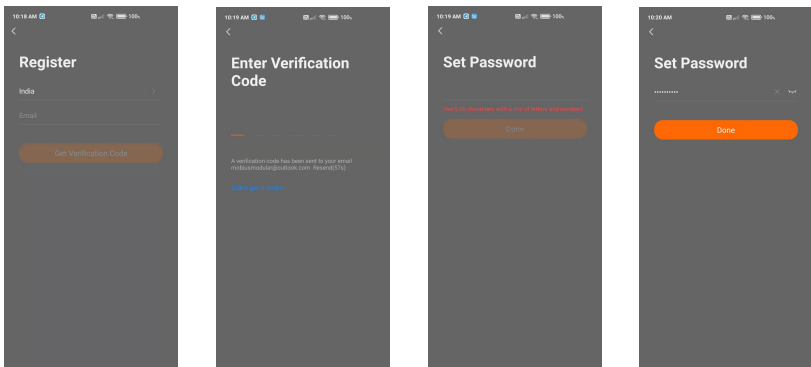

Enter the verification code and if the code is correct, you will be presented with Set Password screen. Set your desired password and select “Done”.

NOTE: Password should contain 6 – 20 alpha-numeric characters.

After setting the password, you will be automatically redirected to the App Permissions screen.

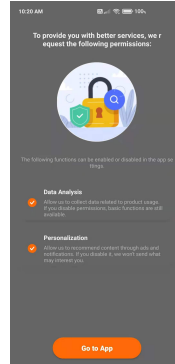

4. The permissions necessary for the App to function correctly will be selected by default. If you are agreeing to give App the necessary permissions, select “Go to App”.

Setting Up the Smart Switch – Using the Abseco App

1. After successfully logging in, you will be presented with the device management main screen. The user profile can be seen at the top left corner. To add personal information and customize basic user profile settings, click on the user profile icon. Upload a profile photo, set a Nickname for the user profile and set the applicable timezone.

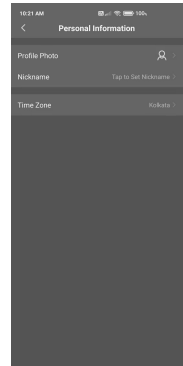
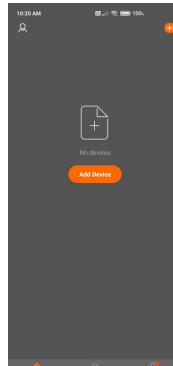

2. Select “Me” in the lower right corner and select “Home Management” to go to the Home Management screen.
3. Select “My Home” to go to the “Complete Home Information” screen.

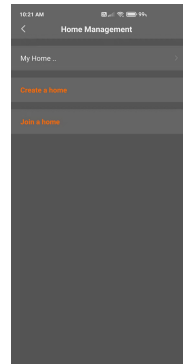
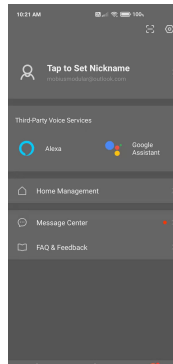

4. If you have already added homes earlier in the Home Management, you can select “Add new” option to access the Edit Home Info screen.
5. Assign a Home Name based on your preference.
NOTE: A maximum of 25 characters are allowed.
6. Next, set the Home Location. Home Location will change based on your phone location. You can also change the Home Location by setting the home coordinates on the map. Select “Save” after making sure the location is correct.
7. You can choose the default room names suggested by the App or click “Add Room” to add a room with custom name.
NOTE: A maximum of 25 characters are allowed.

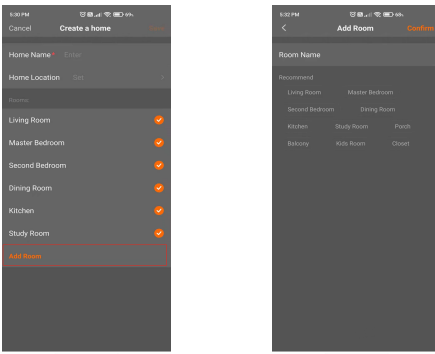

8. After you complete the Home Information and return to the device management main screen, you will see information such as weather, humidity level, and room names.

If you have added more than one home, click the drop-down button on the upper left to view, select and manage other homes.

Now, you can add Abseco Smart Switch to the device list

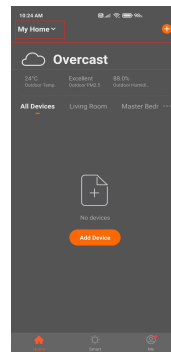

9. Select “Add Device” button in the device management dashboard and a device type selection screen will be displayed. Select “Switch (Wi-Fi)” from the list.

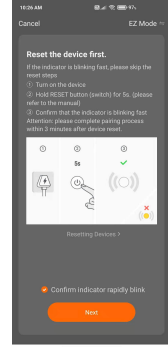
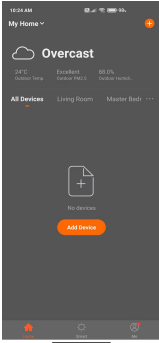

10. You will be now presented with device setup screen. Press and hold Abseco Smart Switch until the indicator light starts blinking to enable setup mode. Then, select "Next" button.
11. Choose your home Wi-Fi network and enter the password. This information will be synced with your Abseco Smart Switch to connect the smart switch to your home Wi-Fi network.

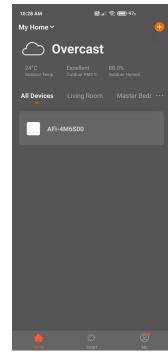
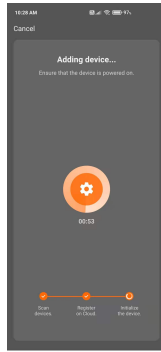
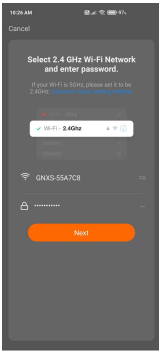

12. After successfully adding the device, go to device management dashboard to view and control the smart switch.

Troubleshooting

If your smart switch is not operating correctly, perform the troubleshooting instructions given below. If problem persists, contact your Abseco Smart Switch dealer or local authorized Abseco service center.

FAULT	PROBABLE CAUSE	REMEDY
<p>Not able to turn on the smart switch (indicator light on the smart switch is OFF)</p>	<p>No power supply or main power supply is OFF.</p>	<p>Make sure that power supply is available and the main power supply is ON.</p>
	<p>Electrical connections to the smart switch are incorrect.</p>	<p>Make sure that the electrical connections to the smart switch are correct. Refer to Wiring Diagram given in Installation Instructions.</p>
<p>Light bulb not turning on when smart switch is turned on (indicator light on smart switch is ON)</p>	<p>The light bulb is burned out.</p>	<p>Make sure that the light bulb is in working condition. If necessary, use a light bulb that is in working condition to make sure that the fault is not due to a burned out light bulb.</p>
	<p>Electrical connections to the smart switch are incorrect.</p>	<p>Make sure that the electrical connections to the smart switch are correct. Refer to Wiring Diagram given in Installation Instructions.</p>
<p>Not able to enable setup mode on smart switch</p>	<p>Correct procedure for enabling setup mode not followed.</p>	<p>Press and hold ON/OFF touch switch for at least 10 seconds and then release. The indicator light on the smart switch will begin blinking to confirm that setup mode is enabled.</p>

FAULT	PROBABLE CAUSE	REMEDY
<p>Unable to connect the smart switch to Abseco Smart App</p>	<p>Bluetooth is OFF in your smartphone.</p>	<p>Make sure that Bluetooth is ON in your smartphone.</p>
	<p>Wi-Fi router not broadcasting at 2.4 GHz frequency.</p>	<p>Make sure your Wi-Fi router is broadcasting at 2.4 GHz frequency; 5 GHz frequency is not supported by Abseco Smart Switch.</p>
	<p>Weak Wi-Fi signal.</p>	<p>Make sure that Wi-Fi signal strength where the smart switch is installed is satisfactory. If your smartphone indicates a weak Wi-Fi signal in that location, then the smart switch will likely have a weak signal as well.</p>
<p>Smart switch is successfully added to the device list in the Abseco Smart App but shows "Offline".</p>	<p>Smart switch is newly added and auto-configuration is incomplete.</p>	<p>After adding the smart switch to the device list in the Abseco Smart App, it needs 1-2 minutes to connect to your router and Internet, and to complete the auto-configuration process. Verify the device status after 1-2 minutes.</p>
<p>Smart switch is in setup mode, but is not appearing in the Abseco Smart App, device setup screen.</p>	<p>WLAN on smartphone not working correctly.</p>	<p>Please close the WLAN of your smartphone then open it after a minute. At the same time, please power off the device if you can, then power up and try again.</p>

Factory Reset

Turn of the electric power supply to the smart switch for at least 10 seconds. Then, switch on the power supply and press and hold the ON/OFF touch switch for 10 seconds.

Additional information on this product and answers to frequently asked questions can be found at our Website.

Official Website: www.abseco.ltd
Service Email Address: care@abseco.ltd

